



AUTOMATIKA
MARIO d.o.o.

Vrteća vrata

2-krila UniTurn



Primjena

Zgrade s velikim protokom prometa i kontrolom klime u prostoru

- Područje transporta (zračne luke, željeznički kolodvori i sl.)
- Maloprodajni dućani
- Hoteli i restorani
- Zdravstvene ustanove

Opcije

Klizna vrata
Zakretna vrata
Izlazi za nuždu

Širina

3.6-5.4 m

Ocjena



3-4 krila RD3 i RD4



Primjena

Objekti sa kontrolom klime u prostoru

- Javne ustanove
- Hoteli
- Područje transporta (zračne luke, željeznički kolodvori i sl.)
- Zdravstvene ustanove

Opcije

Slim
Frame
Izlazi za nuždu

Širina

1.8-3.6 m

Ocjena

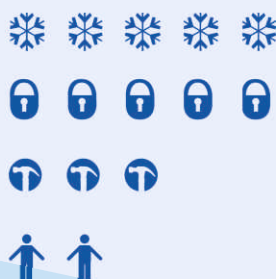

RD - Kontrola ulaza



Primjena

Zgrade sa visoko sigurnosnim zahtjevima

- Državne ustanove
- Javne ustanove
- Elektrane, hidroelektrane i sl.
- Područje transporta (zračne luke, željeznički kolodvori i sl.)

Opcije

Slim
Frame
Izlazi za nuždu

Širina

1.8-2.1 m

Ocjena



Klizna vrata

Frame

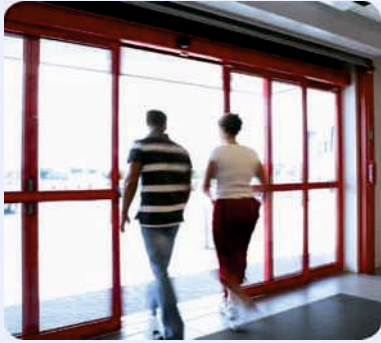

Primjena

Ulazi u

- Maloprodajne trgovine
- Područja transporta (zračne luke, željeznički kolodvori i sl.)
- Poslovne zgrade
- Zdravstvene ustanove

Opcije

Teleskopska
Izlaz za nuždu

Širina okvira

0.9-6.0 m

Ocjena

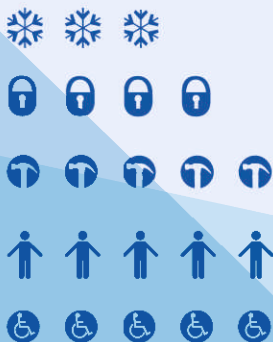

Frame Thermo



Primjena

Ulazi u

- Maloprodajne trgovine
- Područje transporta (zračne luke, željeznički kolodvori i sl.)
- Poslovne zgrade
- Zdravstvene ustanove

Opcije

Teleskopska
Izlaz za nuždu

Širina okvira

0.9-6.0 m

Ocjena



Slim

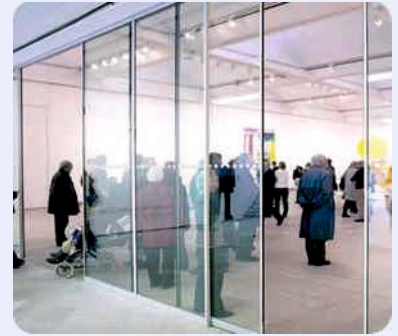

Primjena

Ulazi u

- Maloprodajne trgovine
- Područje transporta (zračne luke, željeznički kolodvori i sl.)
- Poslovne zgrade
- Zdravstvene ustanove

Opcije

Teleskopska
Izlaz za nuždu

Širina okvira

0.9-6.0 m

Ocjena



Klizna vrata

Slim Thermo



Primjena

Ulazi u

- Maloprodajne trgovine
- Područje transporta (zračne luke, željeznički kolodvori i sl.)
- Poslovne zgrade
- Zdravstvene ustanove

Opcije

Teleskopska
Izlaz za nuždu

Širina okvira

0.9-6.0 m

Ocjena

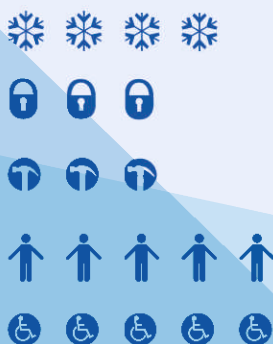

Semi Transparent



Primjena

Ulasci i unutarnja vrata

- Maloprodajne trgovine
- Područje transporta (zračne luke, željeznički kolodvori i sl.)

Opcije

Teleskopska
Izlaz za nuždu

Širina okvira

0.9-6.0 m

Ocjena



Transparent

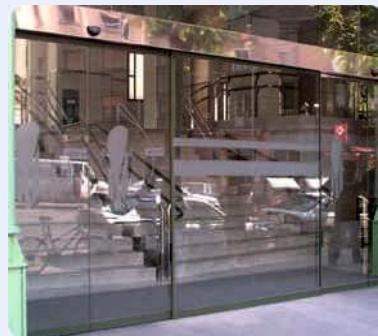

Primjena

Ulasci i unutarnja vrata

- Maloprodajne trgovine
- Područje transporta (zračne luke, željeznički kolodvori i sl.)
- Poslovne zgrade

Opcije

Izlaz za nuždu

Širina okvira

0.9-6.0 m

Ocjena

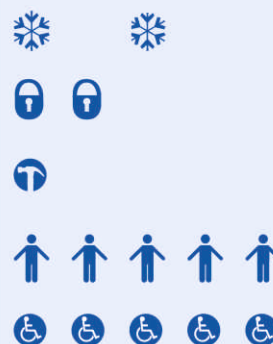

Klizna vrata

Zakrivljena klizna vrata



Primjena

Objekti sa kontrolom klime u prostoru

- Poslovne zgrade
- Hoteli

Opcije

Električni izlaz za nuždu

Širina svijetlog otvora

1.005-2.6 m

Ocjena



Hermetička



Primjena

Sterilni prostori u bolnicama
Sterilni prostori u industriji
Operacijske sale

Opcije

Čelični inox paneli
Dodatni prozor od zračenja

Širina svijetlog otvora

0.8-2.5 m

Ocjena



Upravljačke jedinice



Primjena

Mogu biti integrirani kao dio sistema Besamovih automatskih vrata ali moguće je primjeniti i na vrata drugih proizvođača prema želji kupca.

Opcije

UniSlide
UniSlide Telescopic
UniSlide Hermetic

Širina svijetlog otvora

0.9-4.0 m

Ocjena



Zaokretna vrata

IK-A/IKS-A



Primjena

Idealna su za velika teška vrata i jake udare vjetra

- Maloprodajne trgovine

Opcije

Push/Pull mogućnost
Jednokrilna i dvokrilna izvedba
Kompletna stijena s vratima

Težina i dimenzije

IK-A = 100 kg, IKS-A = 250 kg max.

Ocjena

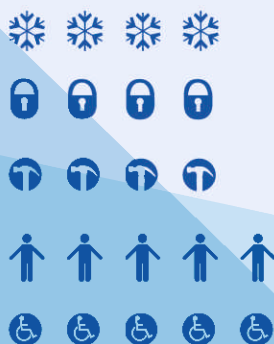

PowerSwing

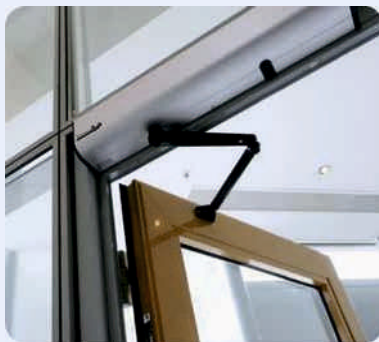

Primjena

Push/Pull mogućnost
Jednokrilna i dvokrilna

Opcije

Push/Pull mogućnost
Jednokrilna i dvokrilna izvedba
Kompletna stijena s vratima

Težina i dimenzije

250 kg max.

Ocjena



OPB



Primjena

Unutarnja zakretna vrata
"light-traffic"
• Javni i privatni objekti

Opcije

Push/Pull mogućnost
Jednokrilna i dvokrilna izvedba

Težina i dimenzije

100 kg

Ocjena

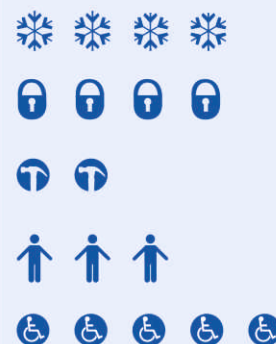

Zaokretna vrata

Balansna vrata



Primjena

Ulazi, uski prolazi i hodnici
• Maloprodajne trgovine

Opcije

Jednokrilna i dvokrilna izvedba

Težina i dimenzije

80 kg - max. vratno krilo š. 1.05 m
BDS-1 širina okvira 0,84-1.170 m
BDS-2 širina okvira 1.560-2.4 m

Ocjena



Kontrole ulaza



Primjena

Javni i privatni objekti

Opcije

EGR - Entrance gates
revolving (vrteća)
EGS - Entrance gates
swing (zakretna)

Opcije

NA

Ocjena

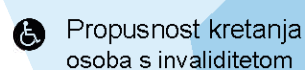
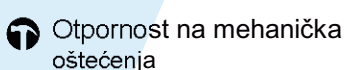

Kontrola klime
u prostoru

Protuprovalna
zaštita

Otpornost na mehanička
oštećenja

Propusnost
kretanja

Propusnost kretanja
osoba s invaliditetom

ASSA ABLOY

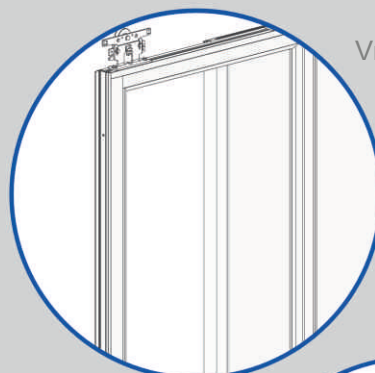

Vratno krilo

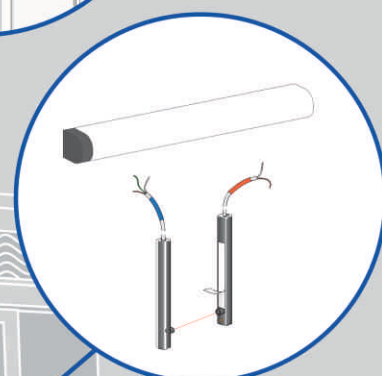

Sigurnosni senzori

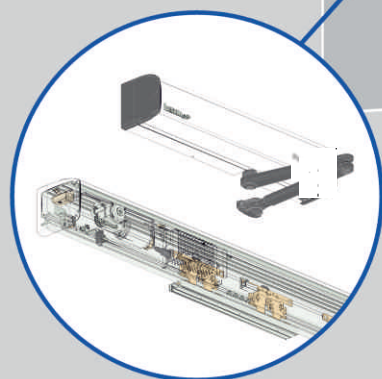

Upravljačke jedinice

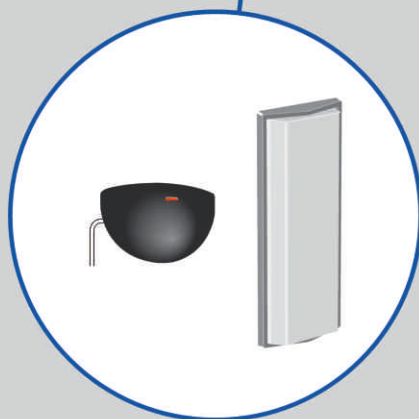

Aktivacijske jedinice

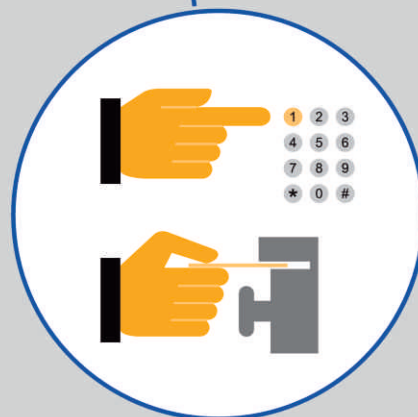

Uređaji za kontrolu ulaza

Servis

Planirano održavanje



Primjena

- Sve vrste automatskih vrata
- Zračne zavjese

Opcije

Ugovorno održavanje
Pružanje usluga

Kontrolni pregledi

Nadogradnje



Primjena

- Sve vrste automatskih vrata

Opcije

Kit za nadogradnju
Sigurnosni kitt
Senzori
Kontrolne jedinice

Hitne intervencije



Primjena

- Sve vrste automatskih vrata
- Zračne zavjese

Rezervni dijelovi



Primjena

- Sve vrste automatskih vrata
- Zračne zavjese

Koje su prednosti sigurnog servisa

- hitne intervencije od 00-24 sata
- produljeni rok trajanja opreme
- kontrola sigurnosti
- Praktičnost i sigurnost
- Otklanjanje nedostataka na vrijeme - proaktivno održavanje
- izbjegavanje velikih neočekivanih materijalnih troškova
- imajte uvijek dobro održavan ulaz
- poštivanje sigurnosnih standarda i propisa
- praćenje rada vrata radi planiranja cjelokupnog održavanja
- savjeti za rukovanje i samostalno održavanje vrata
- kontrola klimatiziranih uvjeta i smanjenje troškova grijanja ili hlađenja

AUTOMATIKA
MARIO d.o.o.

AUTOMATIKA **MARIO** d.o.o.

Naselje Gaza 14B, HR - 47000 Karlovac
OIB: 46172093825
Mob. +385 98 763 701
E-mail: info@automatika-mario.hr
www.automatika-mario.hr

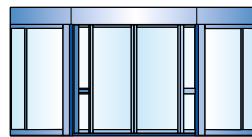
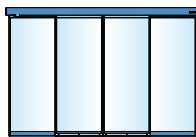
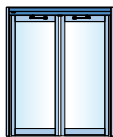

besam™ 

ASSA ABLOY

www.besam.com